

# A New Fuzzy Controlled Extracorporeal Circulation System. First Results of an in-Vitro Investigation

U Schreiber<sup>1</sup>, S Eichhorn<sup>1</sup>, A Mendoza<sup>2</sup>, B Baumgartner<sup>2</sup>, R Bauernschmitt<sup>1</sup>,  
R Lange<sup>1</sup>, A Knoll<sup>2</sup>, M Krane<sup>1</sup>

<sup>1</sup>German Heart Center Munich, Clinic for Cardiovascular Surgery, Technische Universität München, Germany

<sup>2</sup>Fakultät für Informatik, Robotics and Embedded Systems, Technische Universität München, Germany

## Abstract

Extracorporeal circulation (ECC) systems are routinely used during different procedures in cardiac surgery. The ECC used in this experiment was designed to ensure organ perfusion in an emergency situation. While the patient suffers from cardiogenic shock the novel semi-automated-priming extracorporeal circulatory support system (Lifebridge B2T) enables stabilization in or transportation to a clinic.

The focus of this research is the development of an adaptive and robust control system that regulates perfusion based on online data that reflects the current hemodynamic situation of the patient. Using a hydraulic blood circuit model the Fuzzy Controller was tested with a set of four different scenarios: low-, high pressure, with and without simulation of a beating heart. The result showed a good response regulating the centrifugal pump speed of the ECC in such manner that the desired pressure of 70 mmHg was reached after  $x$  sec.

## 1. Introduction

Fuzzy control is a well-established method in control engineering and has been applied to a wide range of problems in diverse disciplines. It is especially useful if a direct analytical description of the control process seems unsuitable. Since fuzzy logic is able to interpret vague and subjective knowledge and allows qualitative system descriptions it is highly qualified for medical decision making.

In this work we present a simple fuzzy-based controller for a mobile extracorporeal circulatory support system (Lifebridge B2T). We therefore build up a hydraulic blood circuit simulating an organism with the possibility to detect the systemic mean pressure with AutoMedic [2]. This served as the input parameter of our control unit [3]. As the set target was 70 mmHg the

controller regulated the pump speed of the ECC in four different scenarios with a primary systemic high- and low pressure, with and without the simulation of a beating heart accordingly.

In this setup we clarify why fuzzy control is an appealing technique for this task but also discuss its difficulties.

## 2. Methods

The hydraulic blood circuit model (Figure 1) consists of two cannulas which are also used in case of percutaneous cannulation [1]. Arterial Cannula Resistance (ACR) represents the cannula for the femoral artery (22 F) and Venous Cannula Resistance (VCR) for the femoral vein (20 F)(Figure 2). These two cannulas appear in the hydraulic model as static resistances at the in- and outlet of the ECC.

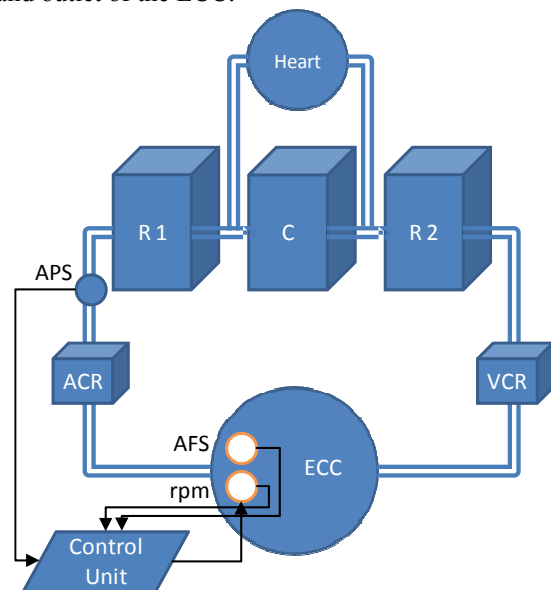

Figure 1. Schematic of the hydraulic blood circuit model

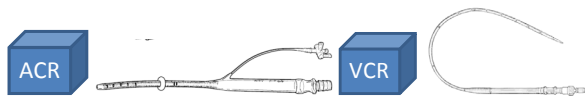

Figure 2. Static resistances of the arterial (ACR) and venous (VCR) cannula

The R1, C, R2 element (Figure 3) represents the organism itself which comprises of an initial resistance (R1), a compliance (C) and an outlet resistance (R2) of the blood circuit. Both resistances are variable and can be altered with electromechanical driven pistons. They are controlled with a LabView 8.3 (National Instruments) program. The artificial organism was configured representing the physiologic situation as seen in animal experiments using 80 kg pigs [2].

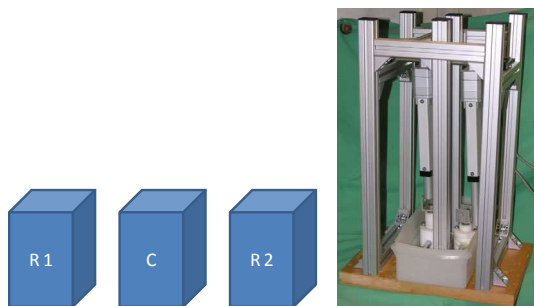

Figure 3. Blood circuit model; R1 representing the inlet resistance, C compliance, R2 the outlet resistance

In the hydraulic blood circuit model also a beating heart was implemented. This is done using a roller pump (Ismatec BVP) simulating a heart beat of 60 beats/minute (Figure 4).



Figure 4. Roller pump (Ismatec BVP) representing the heart

The ECC (LIFEBRIDGE B2T®) is commercially available and consists of a user interface panel and has a

row of sensors integrated (Figure 5). The Arterial Flow Sensor (AFS) detects the inner arterial flow and additionally the rounds per minutes (rpm) of the centrifugal pump are acquired. With a CAN bus connection these data can be collected into the Control Unit and its output value is sent via a serial interface (Figure 6) [2].



Figure 5. Portable heart lung machine with built-in sensors

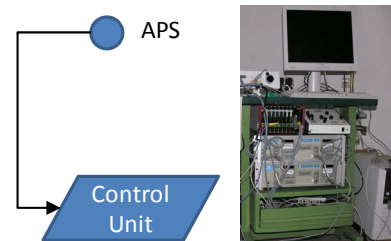

Figure 6. Data acquisition and control unit

With the arterial pressure sensor (APS) the relevant Mean Arterial Pressure (MAP) is being detected. This sensor serves as the input parameter for the Fuzzy Controller with a set of three membership functions: low, medium, and high. The output regulates the pump speed with a correction factor (Delta\_RPM) of the ECC. The rules base corresponds to an inverse relation between in- and output.

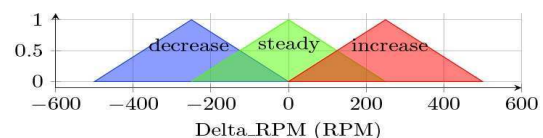
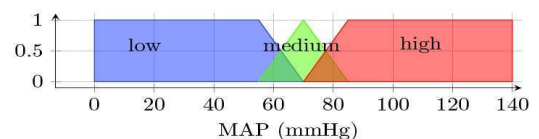

Figure 7. Fuzzy sets for input variable MAP and output value Delta\_RPM.

Four scenarios were conducted simulating a vasoconstricted organism, with (3) and without beating heart (1), and a vasodilated organism with (4) and without beating heart (2). Before the controller was activated, R1 was adjusted to achieve an initial MAP of 30 mmHg in scenario 1 and 3 and 90 mmHg in scenarios 2 and 4. Additionally the pump speed was set to a specific speed: 2000 rpm (1 and 3), and 3800 rpms (2 and 4).

Table 1. Set of four different scenarios.

| Rpm  | MAP [mmHg] | Heart | No. |
|------|------------|-------|-----|
| 2000 | 30         |       | 1   |
| 3800 | 90         |       | 2   |
| 2000 | 30         | X     | 3   |
| 3800 | 90         | X     | 4   |

### 3. Results

In experiments the fuzzy controller displayed its expected behaviour. The following figures show from top to bottom: the MAP, yellow; the arterial flow AFS), cyan; the control output data (Delta\_RPM), red; and the current rpm, blue. During the simulation of vasoconstriction (Figure 8 and 9), the controller reacts with an decrease of the current pump speed until the MAP is at the desired 70 mmHg again. During the simulation of vasodilation (Figure 10 and 11) the pump speed is increased to counteract the too low MAP. Both sets show smooth control characteristics regardless of the noisy signal induced by the simulating heartbeat. Within 20 to 30 seconds the target is reached. In all of the cases an overshoot and oscillations could be seen.

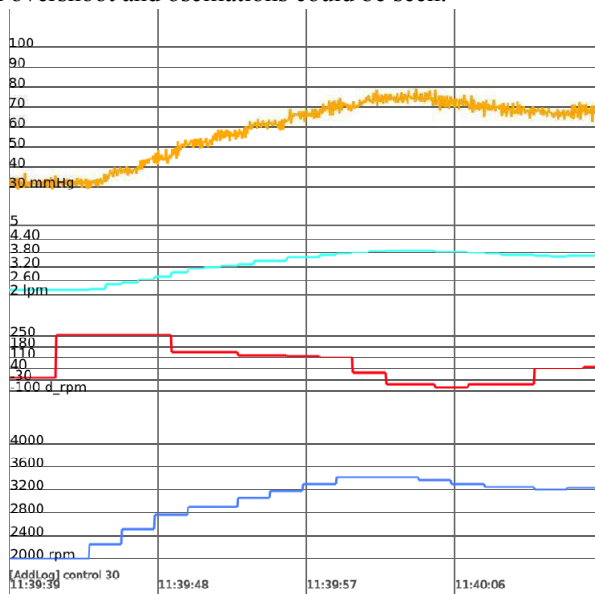

Figure 8. Starting pressure at 30 mmHg (MAP) without heart simulation (1).

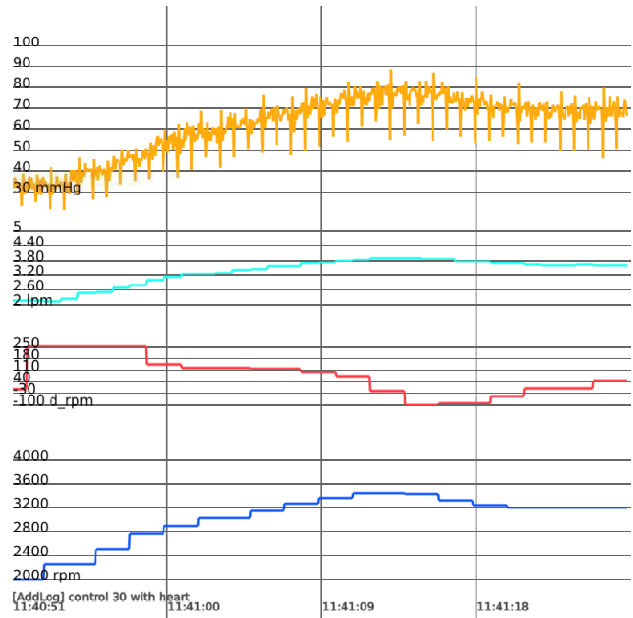

Figure 9. Starting pressure at 30 mmHg (MAP) with heart simulation (3).

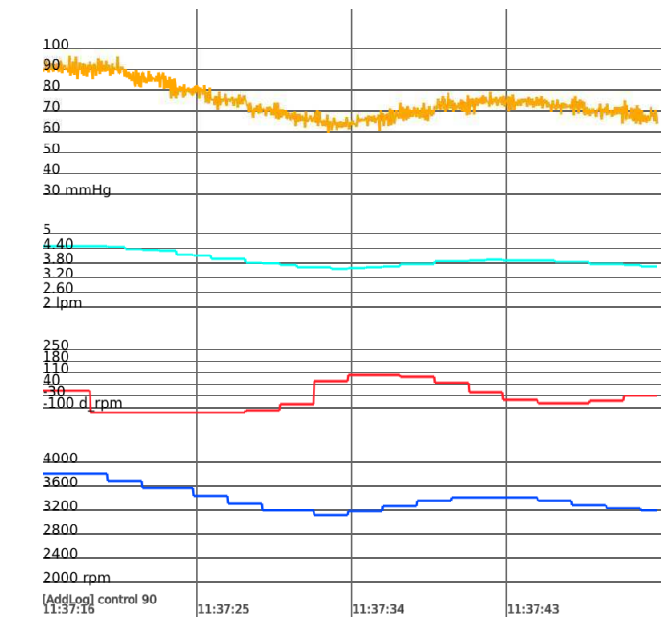

Figure 10. Starting pressure at 90 mmHg (MAP) without heart simulation (2).

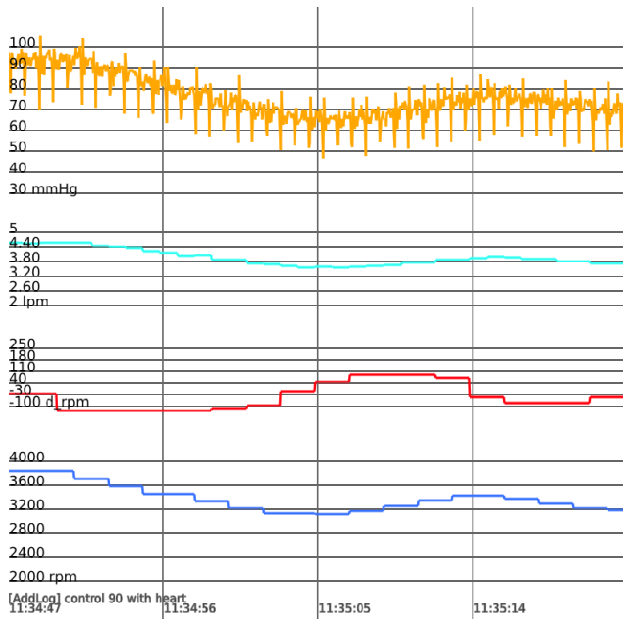

Figure 11. Starting pressure at 90 mmHg (MAP) with heart simulation (4).

#### 4. Discussion and conclusions

Fuzzy systems are popular in medical applications, since it is often impossible to give a precise, analytical description of the system to be controlled. Hanson [4] states, that medical practitioners strive for objectivity and precision while dealing with data that are inherently imprecise. Fuzzy Logic permits simultaneous membership in more than one set (see Fig. 7) and thus is able to model systems with roughly known response characteristics.

However, disadvantages of the method must not be ignored. Also fuzzy controllers might have tuning problems. An optimal rulebase needs to be defined and, consequently optimal fuzzy sets must be found. This might be a difficult task and a fuzzy controller is only as good as the expertise of its designer.

Improvements have to be done in terms of the overshoot and oscillation. Instead of setting a singular target value of 70 mmHg for the MAP one could define a target range (65-75 mmHg, e.g.).

Another way to reduce the observed problems is to consider and evaluate time delays of the system (how long does the pump need to reach a certain speed, how long does it take to observe and process a change in MAP?).

As especially in medical applications there are numerous variables which have to be captured in order to monitor the patient's condition, the design of fuzzy systems with adequate rulebases can quickly become complex. Such systems have to be robust, cover all possible circumstances, but at the same time an automated ECCS must guarantee reliability and never expose the patient to any risk.

Future work has to be conducted in order to improve this preliminary approach, first with the hydraulic blood circuit and then evaluated in an animal experiment.

#### Acknowledgements

This work has been supported by an unrestricted educational grant from the Bayerische Forschungsstiftung.

#### References

- [1] Krane M., Schreiber U., Mendoza A., Voss B., Badiu C., Lange R., Bauernschmitt R.: First experience with a new portable cardiopulmonary bypass system - LIFE BRIDGE B2T with percutaneous femoral cannulation. *Computers in Cardiology*, 269-272, 2008
- [2] Mendoza A., Baumgartner B., Schreiber U., Krane M., Knoll A., Bauernschmitt B.: AutoMedic: Fuzzy Control Development Platform for a Mobile Heart-Lung Machine. *IFMBE Proceedings*, in process, 2009
- [3] Baumgartner B., Mendoza A., Schreiber U., Eichhorn S., Krane M., Bauernschmitt R., Knoll A.: A Simple Fuzzy Controller for an Extra-Corporeal Circulation System - Limitations and Potentials. *5<sup>th</sup> Russian Bavarian Congress Proceedings 2009*
- [4] Hanson C.W., Marshall B.E.: Artificial intelligence applications in the intensive care unit. *Crit Care Med*, 29, 427-435, 2001

Address for correspondence

Dr.-Ing. Ulrich Schreiber  
 German Heart Center Munich  
 Clinic for Cardiovascular Surgery  
 Technische Universität München  
 Lazarettstr. 32  
 80636 Munich, Germany  
 schreiberu@dhm.mhn.de